

VDX3-6754

with

**DM&P Vortex86DX3
1GHz processor**

Version 4.0

Copyright

The information in this manual is subject to change without notice for continues improvement in the product. All rights are reserved. The manufacturer assumes no reasonability for any inaccuracies that may be contained in this document and makes no commitment to update or to keep current the information contained in this manual.

No part of this manual may be reproduced, copied, translated or transmitted, in whole or in part, in any form or by any means without the prior to written permission of ICOP Technology Inc.

Copyright © 2015 ICOP Technology Inc

Trademarks Acknowledgement

Vortex86DX3™ is the registered trademark of DM&P Electronics Inc. Other brand names and product names that appear in this document are the properties and registered trademarks of their respective owners. All names mentioned herewith are served for identification purpose only.

Revision History

Revision	Date	Remark
1.0	September, 2015	First version release
2.0	April, 2016	Typo Correction for connector J13, J14, J15, and J16
3.0	September 26 th , 2016	New Add: Dual Core Part Number
4.0	June 8 th , 2017	New Add: Working Temperature for Dual Core version

Table of Contents

1	General Information.....	1
1.1	Overview	1
1.2	Block diagram	2
1.3	Specifications	3
1.4	Ordering Information	5
1.4.1	VDX3-6754.....	5
1.4.2	Cable Set	5
1.4.3	SATA DOM	6
2	Hardware Information	8
2.1	Dimension	8
2.2	Board Outline	9
2.3	Connector Location	10
2.4	Connector and Jumper Summary	11
2.5	Pin Assignments & Jumper Settings	12
	J1: JTAG.....	12
	J2: PS/2 Keyboard	12
	J3: PS/2 Mouse	12
	J4: SATA DOM	12
	J5: SATA DOM Power	12
	J6: USB 0&1.....	13
	J7: LAN	13
	J8: VGA.....	13
	J9: Reset.....	13
	J10A: PC/104 Connector – 64 pin	14
	J10B: PC/104 Connector – 40 pin.....	15

J11: Buzzer	15
J12: 4P Power Source (Interconnect to PC/104 – J10)	16
J13: COM1 (RS232/485/TTL optional)	16
J14: COM2 (RS232/485/TTL optional)	16
J15: COM3 (RS232/485/TTL optional)	16
J16: COM4 (RS232/485/TTL optional)	17
J17: GPIO (Port 0/1)	17
J18: PRINT	18
J19: LCD Connector	18
J20: LVDS	19
J21: LINE-OUT	19
J22: MIC-IN	19
J23: Touch Controller	19
J24: Power Connector	19
System Mapping	20
3 Software Resources	23
3.1 ICOP Technical Resource Website	23
3.2 Vortex86 Processor Programming Guide	23
4 Technical support	24
4.1 LCD	24
4.1.1 Introduction	24
4.1.2 Pin Assignment of LVDS and TFT-LCD	24
4.2 BIOS	27
4.2.1 Introduction	27
4.2.2 CPU Clock Adjusting	27
4.2.3 Console Redirection	27
4.2.4 Serial ports Switching	28

4.2.5 IDE Configuration..... 29

4.2.6 Advanced PCI/PnP Setting..... 31

4.2.7 ACPI Enable..... 32

4.2.8 LCD Panel Setting..... 33

Warranty.....35

1 General Information

1.1 Overview

The VDX3-6754 PC/104 family of low-power x86 embedded controller is designed to meet PC/104 specification with backward compatibility to provide migration path for projects facing end-of-life challenges with their existing x86 based PC/104 controller.

In addition, the VDX3-6754 family of controller is designed as a plug in replacement, with backward compatibility to support legacy software to help extend existing product life cycle without heavy re-engineering.

The VDX3-6754 is suitable for broad range of data-acquisition, industrial automation, process control, automotive controller, AVL, intelligent vehicle management device, medical device, human machine interface, robotics, machinery control and more.

1.2 Block diagram

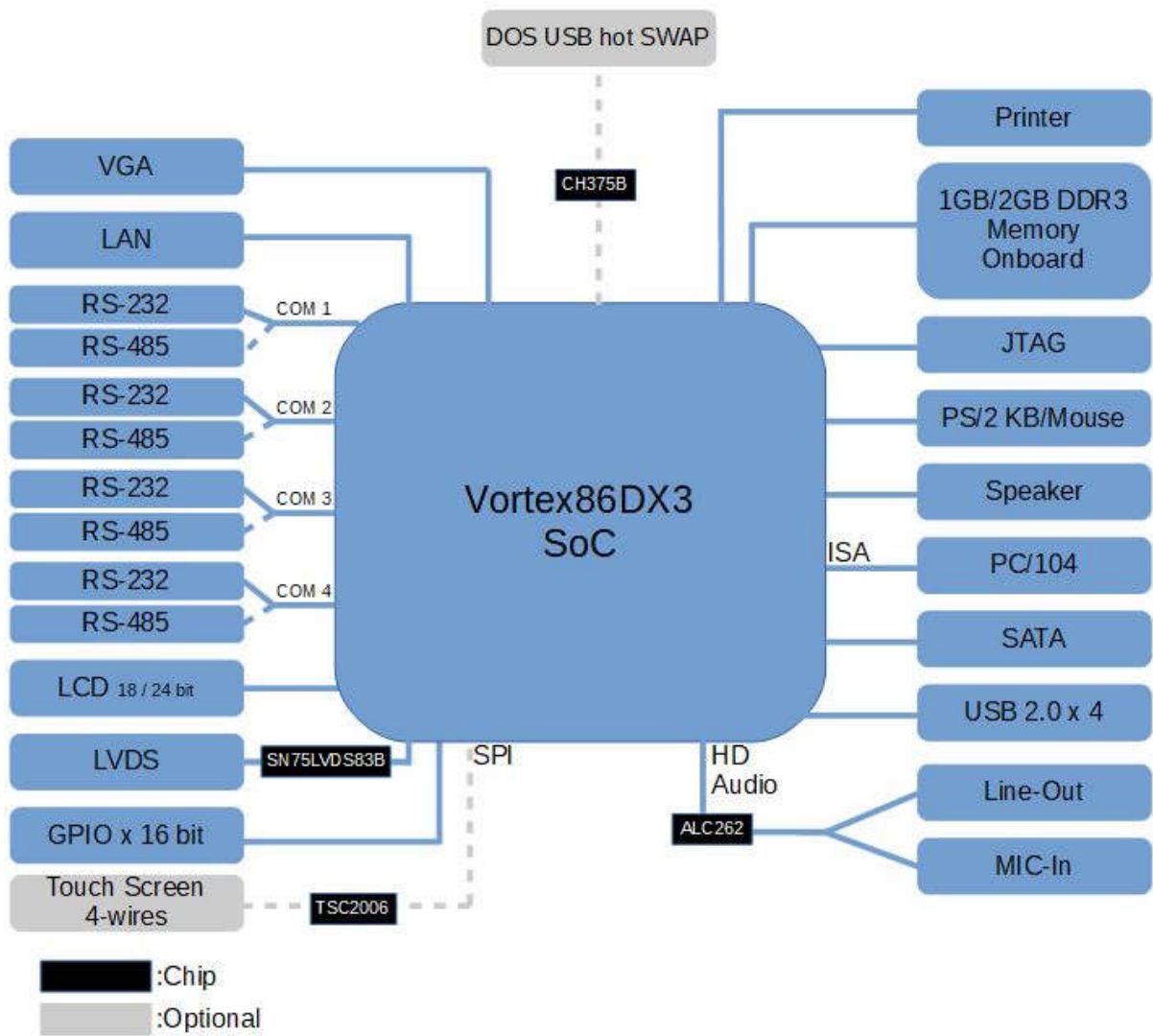

1.3 Specifications

Processor	DM&P SoC CPU Vortex86DX3 - 1GHz Real Time Clock with Lithium Battery Backup
Cache	L1:32K I-Cache, 32K D-Cache, L2 Cache:512KB
Bus	PC/104 Standard Compliant
System Memory	1GB/2GB DDR3 Onboard
Watchdog Timer	Software programmable from 30.5 us to 512 seconds x2 sets(Watchdog 1 fully compatible with M6117D)
Display	Integrated 2D VGA chip with dual display support (VGA + TTL/VGA + LVDS) VGA: Maximum resolution up to 1920x1080 @ 60Hz LVDS: Maximum resolution up to 1024x768 @ 60Hz 18/24-bit single channel LVDS(Default 24-bit LVDS support)
LAN	Integrated 10/100Mbps Ethernet x1
Audio	ALC262 (HD Audio)
Optional Interface	*DOS USB Hot SWAP x1
I/O Interface	SATA 7P Connector x1 RS-232/485 port x4 USB port (Ver. 2.0) x2 Parallel port x1 16-bit GPIO port x1 10/100Mbps Ethernet port x1

*For more detail, please contact ICOP sales.

Connectors	<p>SATA 7P for SATA x1</p> <p>2.0mm 26-pin box header for Printer x1</p> <p>20.0mm 20-pin box header for 16-bit GPIO x1</p> <p>2.0mm 10-pin box header for USB x1</p> <p>2.0mm 10-pin box header for RS232 x4</p> <p>2.0mm 44-pin box header for LCD x1</p> <p>2.0mm 16-pin header for LVDS x1</p> <p>2.0mm 8-pin header for Ethernet x1</p> <p>2.0mm 10-pin box header for VGA x1</p> <p>2.54mm 5-pin header for Keyboard x1</p> <p>2.54mm 5-pin header for Mouse x1</p> <p>2.54mm 4-pin header for -5V, -12V +12V, GND x1</p> <p>2.54mm 2-pin header for Reset x1</p> <p>1.25mm 6-pin wafer for JTAG x1</p> <p>1.25mm 4-pin wafer for Line-out/MIC-in x2</p> <p>1.25mm 4-pin wafer for Touch Controller x1 (Optional)</p>
Power Requirement	Single Voltage +5V @1.3A (Typical)
Weight	80g
Dimensions	90mm x 96mm (3.54 x 3.77 inches)
Operating Temp.	<p>-20°C ~ +70°C (Single Core)</p> <p>-10°C ~ +60°C (Dual Core)</p> <p>-40°C ~ +85°C (Optional for Single Core)</p> <p>-20°C ~ +70°C (Optional for Dual Core)</p>
Operating System Support	<p>Free DOS, DOS 6.22, PC DOS 7.1, DR-DOS, x-DOS, OS/2, Windows 7, Windows Embedded Standard 7, Windows Embedded Compact 7, Windows Embedded Compact 6, Windows XP Professional, Windows Embedded Standard(XPE), POS Ready(WePOS), Embedded Linux, X-Linux, QNX, Vxworks and FreeBSD.</p>

1.4 Ordering Information

1.4.1 VDX3-6754

Product Name	1GB DDR3	2GB DDR3	Touch Function	Dual Core
VDX3-6754-1G	V			
VDX3-6754-2C-1G	V			V
VDX3-6754-1G-T	V		V	
VDX3-6754-2C-1G-T	V		V	V
VDX3-6754-2G		V		
VDX3-6754-2C-2G		V		V
VDX3-6754-2G-T		V	V	
VDX3-6754-2C-2G-T		V	V	V

1.4.2 Cable Set

Product Name	Contents
CABLE-SET-6754	NET4X2(2.0) x1 RS232(2.0) x4 USB(2.0) x1 PRINT(2.0) x1 VGA(2.0) x1 GPIO(2.0) x1 PS2KB(TEST) x2 CABLE-AUDIO-4P(1.25) x2

1.4.3 SATA DOM

Product Name	MLC	SLC	0°C ~ +70°C	-40°C ~ +85°C
SDM-SST-2G-H-M	V		V	
SDM-SST-4G-H-M	V		V	
ISATA-8G-H-M	V		V	
ISATA-16G-H-M	V		V	
ISATA-32G-H-M	V		V	
ISATA-4G-H-M-X	V			V
ISATA-8G-H-M-X	V			V
ISATA-16G-H-M-X	V			V
ISATA-32G-H-M-X	V			V
ISATA-1G-H-S		V	V	
ISATA-2G-H-S		V	V	
ISATA-4G-H-S		V	V	
ISATA-8G-H-S		V	V	
ISATA-16G-H-S		V	V	
SDM-SST-2G-H-S-X		V		V
SDM-SST-4G-H-S-X		V		V
SDM-SST-8G-H-S-X		V		V
ISATA-16G-H-S-X		V		V

Illustration of “SDM-SST” placed on VDX3-6754
(ISATA series illustration is the same)

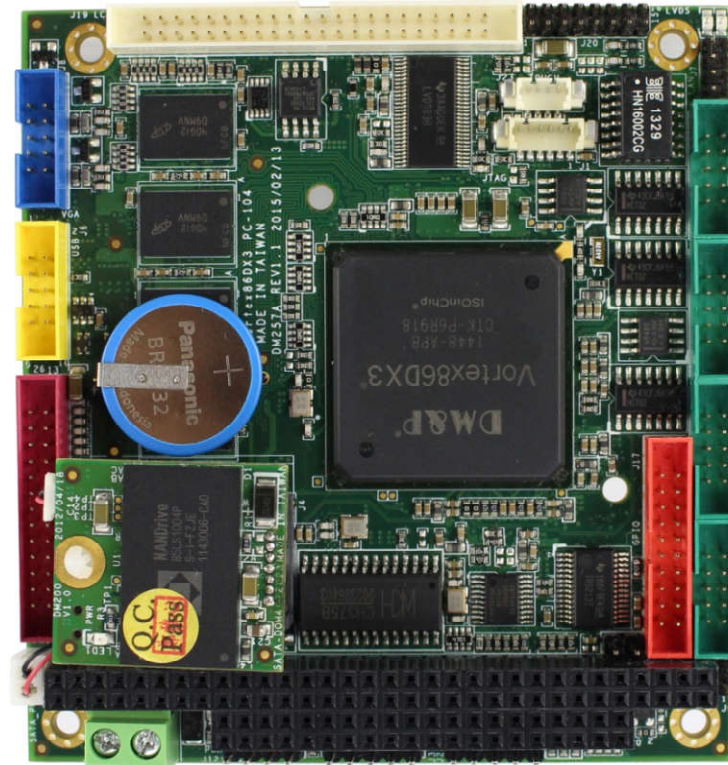

The SATA DOM will be higher than the top of PC/104 connector 4 millimeter when the SATA DOM placed on VDX3-6754.

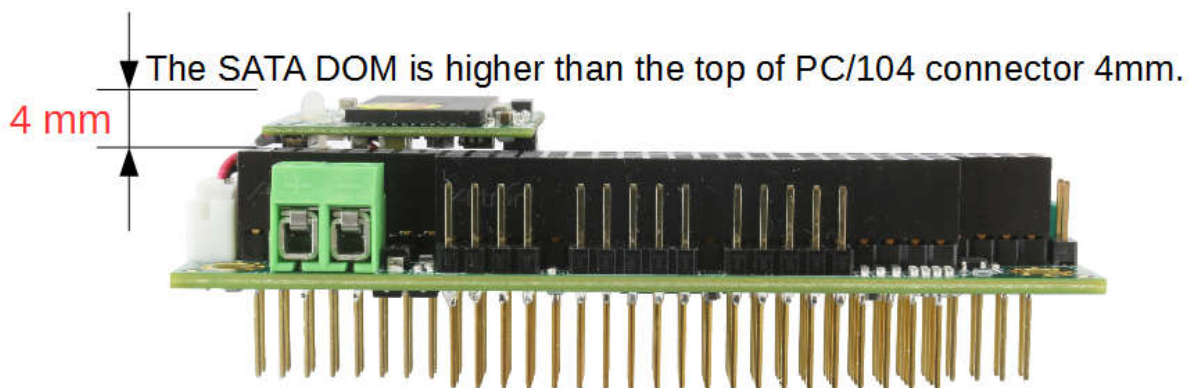

2 Hardware Information

2.1 Dimension

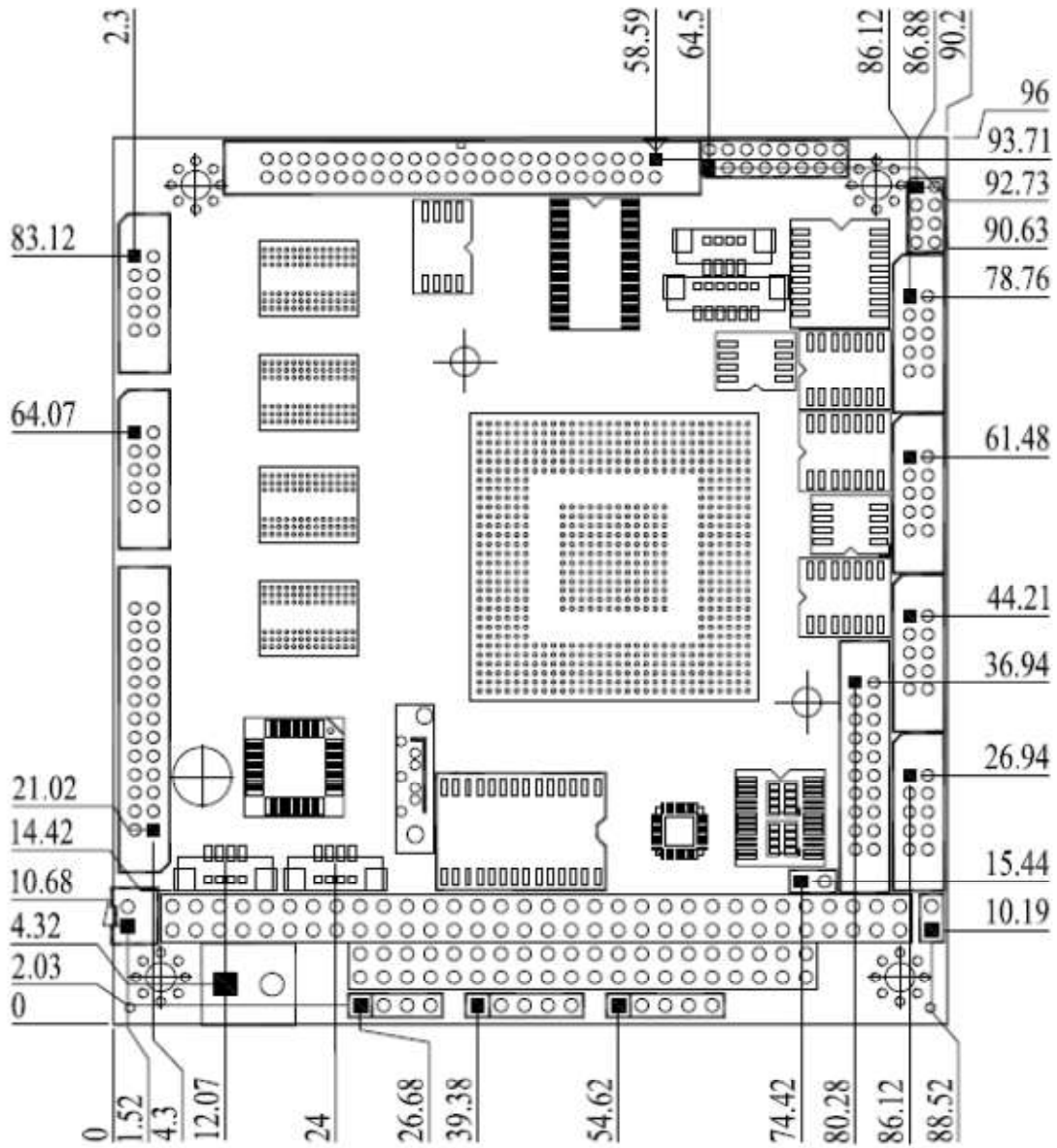

2.2 Board Outline

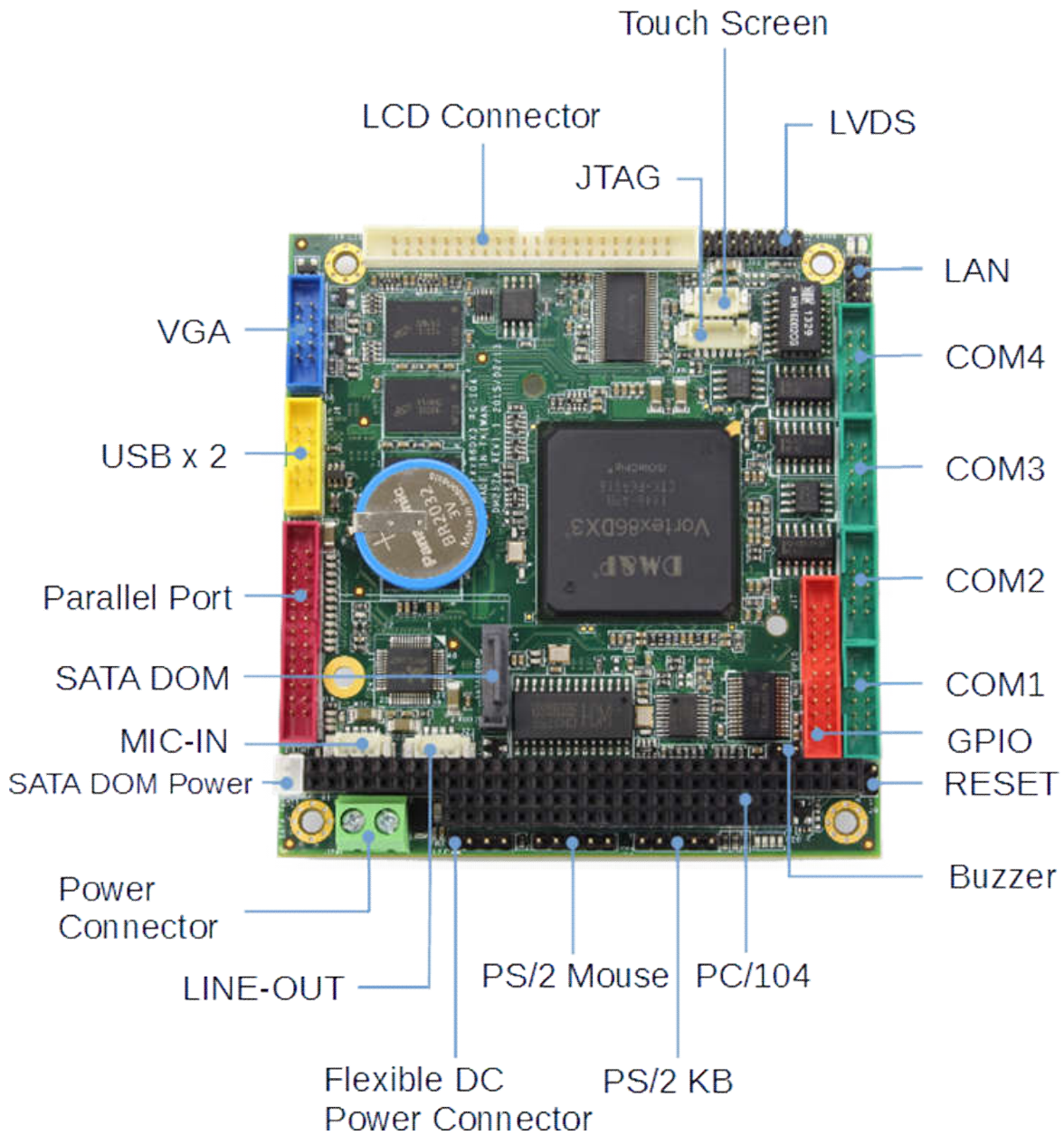

2.3 Connector Location

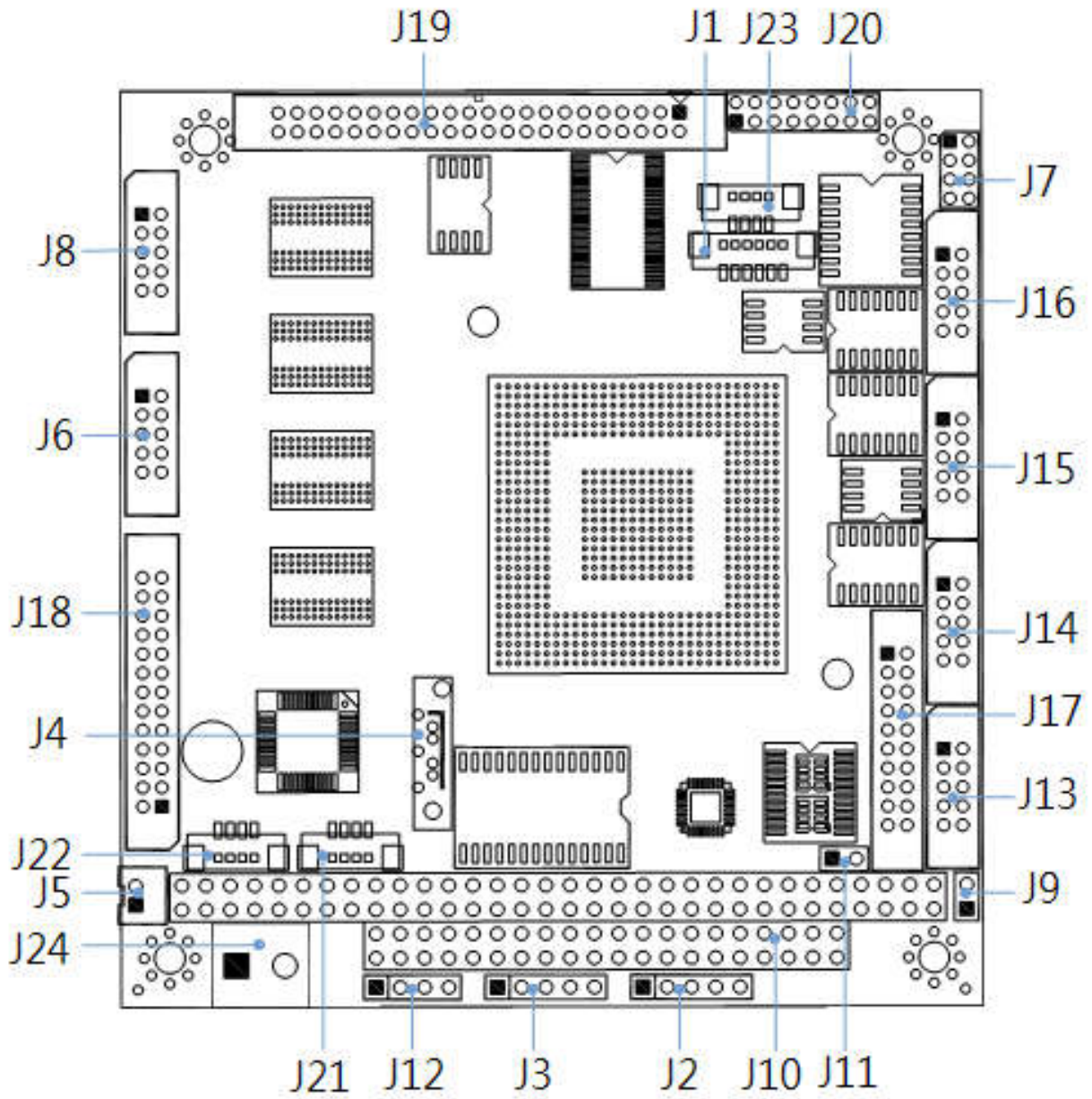

2.4 Connector and Jumper Summary

Nbr.	Name	Type of Connections	Nbr of Pin
J1	JTAG	Wafer, 1.25mm, 1x6	6
J2	PS/2 Keyboard	Box Header, 2.54mm, 1x5	5
J3	PS/2 Mouse	Box Header, 2.54mm, 1x5	5
J4	SATA DOM	SATA 7P Connector, 7x1	7
J5	SATA DOM Power	Box Header, 2.0mm, 1x2	2
J6	USB	Pin Header, 2.0mm, 5x2	10
J7	LAN	Pin Header, 2.0mm, 4x2	8
J8	VGA	Pin Header, 2.0mm, 5x2	10
J9	Reset	Pin Header, 2.54mm, 1x2	2
J10A	PC/104 Connector – 64 pin	Box Header, 2.54mm, 32x2	64
J10B	PC/104 Connector – 40 pin	Box Header, 2.54mm, 20x2	40
J11	Buzzer	Pin Header, 2.54mm, 1x2	2
J12	4P Power Source (Interconnect to PC/104 – J10)	Pin Header, 2.54mm, 4x1	4
J13	COM1(RS232/485/TTL optional)	Box Header, 2.0mm, 5x2	10
J14	COM2(RS232/485/ TTL optional)	Box Header, 2.0mm, 5x2	10
J15	COM3(RS232/485/ TTL optional)	Box Header, 2.0mm, 5x2	10
J16	COM4(RS232/485/TTL optional)	Box Header, 2.0mm, 5x2	10
J17	GPIO (Port 0/1)	Box Header, 2.0mm, 10x2	20
J18	PRINT	Box Header, 2.0mm, 13x2	26
J19	LCD Connector	Box Header, 2.0mm, 22x2	44
J20	LVDS	Pin Header, 2.0mm, 8x2	16
J21	LINE-OUT	Wafer, 1.25mm , 4x1	4
J22	MIC-IN	Wafer, 1.25mm , 4x1	4
J23	Touch Controller (Optional)	Wafer, 1.25mm , 4x1	4
J24	Power Connector	Terminal Block 5.0mm, 2x1	2
PWR LED	Power Active LED (Red)	SMD LED	
LED 3	LAN LINK/Active LED (Green)	SMD LED	
LED 4	LAN Duplex LED (Yellow)	SMD LED	

2.5 Pin Assignments & Jumper Settings

J1: JTAG

For ICOP use only

J2: PS/2 Keyboard

Pin#	Single Name	Pin #	Single Name
1.	KBCLK	2	KBDATA
3	NC	4	GND
5	VCC		

J3: PS/2 Mouse

Pin#	Single Name	Pin #	Single Name
1.	MSCLK	2	MSDATA
3	NC	4	GND
5	VCC		

J4: SATA DOM

Pin#	Single Name	Pin #	Single Name
1.	GND	2	TX+
3	TX-	4	GND
5	RX-	6	RX+
7*	GND		

*The pin 7 supports +5V (Optional)

J5: SATA DOM Power

Pin#	Single Name	Pin #	Single Name
1.	VCC	2	GND

J6: USB 0&1

Pin#	Single Name	Pin #	Single Name
1.	VCC	2	VCC
3	LUSBD0-	4	LUSBD1-
5	LUSBD0+	6	LUSBD1+
7	GND	8	GND
9	GGND	10	GGND

*USB1 supports DOS USB hot SWAP (Optional).

For more detail, please contact ICOP sales.

J7: LAN

Pin#	Single Name	Pin #	Single Name
1.	LTX+	2	LTX-
3	LRX+	4	DUPLEX
5	LED0+	6	LRX-
7	LED1+	8	LINK/ACTIVE

J8: VGA

Pin#	Single Name	Pin #	Single Name
1.	R OUT	2	GND
3	G OUT	4	GND
5	B OUT	6	GND
7	HSYNC_A	8	GND
9	VSYNC_A	10	GND

J9: Reset

Pin#	Single Name	Pin #	Single Name
1.	RST_SW	2	GND

J10A: PC/104 Connector – 64 pin

Pin#	Single Name	Pin #	Single Name
1.	IOCHCHK*	2	GND
3	SD7	4	RESETDRV
5	SD6	6	VCC
7	SD5	8	IRQ9
9	SD4	10	-5V
11	SD3	12	RDQ2
13	SD2	14	-12V
15	SD1	16	OWS
17	SD0	18	+12V
19	IOCHRDY	20	GND
21	AEN	22	SMEMW*
23	SA19	24	SMEMR*
25	SA18	26	IOW*
27	SA17	28	IOR*
29	SA16	30	DACK3*
31	SA15	32	DRQ3
33	SA14	34	DACK1*
35	SA13	36	DRQ1*
37	SA12	38	REFRESH*
39	SA11	40	SYSCLK
41	SA10	42	IRQ7
43	SA9	44	IRQ6
45	SA8	46	IRQ5
47	SA7	48	IRQ4
49	SA6	50	IRQ3
51	SA5	52	DACK2*
53	SA4	54	TC
55	SA3	56	BALE
57	SA2	58	VCC
59	SA1	60	OSC
61	SA0	62	GND
63	GND	64	GND

J10B: PC/104 Connector – 40 pin

Pin#	Single Name	Pin #	Single Name
1.	GND	2	GND
3	MEMCS16*	4	SBHE*
5	IOCS16*	6	SA23
7	IRQ10	8	SA22
9	IRQ11	10	SA21
11	IRQ12	12	SA20
13	IRQ15	14	SA19
15	IRQ14	16	SA18
17	DACK0*	18	SA17
19	DRQ0	20	MEMR*
21	DACK5*	22	MEMW*
23	DRQ5	24	SD8
25	DACK6*	26	SD9
27	DRQ6	28	SD10
29	DACK7	30	SD11
31	DRQ7	32	SD12
33	VCC	34	SD13
35	MASTER*	36	SD14
37	GND	38	SD15
39	GND	40	NC

J11: Buzzer

Pin#	Single Name	Pin #	Single Name
1.	Buzzer	2	VCC

J12: 4P Power Source (Interconnect to PC/104 – J10)

Pin#	Single Name
1.	-5V
2	-12V
3	+12V
4	GND

J13: COM1 (RS232/485/TTL optional)

Pin#	Single Name	Pin #	Single Name
1.	DCD1/1RS485-	2	RXD1/1RS485+
3	TXD1	4	DTR1
5	GND	6	DSR1
7	RTS1	8	CTS1
9	RI1	10	NC

J14: COM2 (RS232/485/TTL optional)

Pin#	Single Name	Pin #	Single Name
1.	DCD2/2RS485-	2	RXD2/2RS485+
3	TXD2	4	DTR2
5	GND	6	DSR2
7	RTS2	8	CTS2
9	RI2	10	NC

J15: COM3 (RS232/485/TTL optional)

Pin#	Single Name	Pin #	Single Name
1.	DCD3/3RS485-	2	RXD3/3RS485+
3	TXD3	4	DTR3
5	GND	6	DSR3
7	RTS3	8	CTS3
9	RI3	10	NC

J16: COM4 (RS232/485/TTL optional)

Pin#	Single Name	Pin #	Single Name
1.	DCD4/4RS485-	2	RXD4/4RS485+
3	TXD4	4	DTR4
5	GND	6	DSR4
7	RTS4	8	CTS4
9	RI4	10	NC

J17: GPIO (Port 0/1)

Pin#	Single Name	Pin #	Single Name
1.	GND	2	VCC
3	GP00	4	GP10
5	GP01	6	GP11
7	GP02	8	GP12
9	GP03	10	GP13
11	GP04	12	GP14
13	GP05	14	GP15
15	GP06	16	GP16
17	GP07	18	GP17
19	VCC	20	GND

J18: PRINT

Pin#	Single Name	Pin #	Single Name
1.	STB-	14	AFD-
2	PD0	15	ERR-
3	PD1	16	INIT-
4	PD2	17	SLIN-
5	PD3	18	GND
6	PD4	19	GND
7	PD5	20	GND
8	PD6	21	GND
9	PD7	22	GND
10	ACK-	23	GND
11	BUSY	24	GND
12	PE	25	GND
13	SLCT	26	NC

J19: LCD Connector

Pin#	Single Name	Pin #	Single Name
1.	+3.3V	2	+3.3V
3	LG2	4	LG3
5	LG4	6	LG5
7	NC	8	NC
9	LR0	10	LR1
11	LR2	12	LR3
13	LR4	14	LR5
15	GND	16	NC
17	NC	18	NC
19	NC	20	GND
21	NC	22	NC
23	LB0	24	LB1
25	LB2	26	LB3
27	LB4	28	LB5
29	NC	30	NC
31	LG0	32	LG1
33	GND	34	GND
35	NC	36	LCLK
37	NC	38	LDE
39	NC	40	LHSYNC
41	NC	42	LVSYNC
43	LBACKL	44	LVDDEN

J20: LVDS

Pin#	Single Name	Pin #	Single Name
1.	VCC3 (+3.3V)	2	VCC3 (+3.3V)
3	GND	4	GND
5	Y0P	6	Y0M
7	Y1M	8	Y1P
9	Y2P	10	Y2M
11	GND	12	GND
13	CLKOUTM	14	CLKOUTP
15	Y3M	16	Y3P

J21: LINE-OUT

Pin#	Single Name
1	LOUTR
2	GND
3	GND
4	LOUTL

J22: MIC-IN

Pin#	Single Name
1	MICVREF
2	GND
3	GND
4	MIC-IN

**J23: Touch Controller
(Optional)**

Pin#	Single Name
1	Y-
2	X-
3	Y+
4	X+

*PS/2 Mouse will be disabled when Touch function is required.

J24: Power Connector

Pin#	Single Name
1	+5V
2	GND

System Mapping

Memory Mapping		
Address	Description	Usage
00000000 – 0009FFFF	System RAM	*
000A0000 – 000AFFFF	EGA/VGA Video Memory	*
000B0000 – 000B7FFF	MDA RAM, Hercules graphics display RAM	*
000B8000 – 000BFFFF	CGA display RAM	*
000C0000 – 000C7FFF	EGA/VGA BIOS ROM	*
000C8000 – 000CFFFF	Boot ROM enable	
000CC000 – 000CFFFF	Console Redirection enable	
000D0000 – 000D7FFF	Expansion ROM space	
000D8000 – 000D8FFF	SPI Flash Emulation Floppy A Enable	
000DC000 – 000DFFFF	Expansion ROM Space	
000E0000 – 000EFFFF	USB Legacy SCSI ROM space	
000F0000 – 000FFFFFF	Motherboard BBIOS	*
FEFDBC00 – FEFDBCFF	Standard OpenHCD USB Host Controller	*
FEFBB400 – FEFBB4FF	Onboard Ethernet Adapter	*
FEFDB800 – FEFDBFFF	Standard Enhanced PCI to USB Host Controller	*

I/O Mapping		
Address	Description	Usage
0000h – 000Fh	DMA 8237-1	*
0020h – 0021h	PIC 8259-1	*
0022h – 0023h	Indirect Access Registers (6117D configuration port)	*
0040h – 0043h	Timer Counter 8254	*
0060h	Keyboard / Mouse data port	
0061h	Port B + NMI control port	*
0062h – 0063h	8051 download 4k address counter	
0064h	Keyboard/ Mouse status/ command port	
0065h	WatchDog0 reload counter	
0070h – 0071h	CMOS RAM port	*
0072h – 0075h	MTBF control register	*
0078h – 007Ch	GPIO port 0,1,2,3,4 default setup	*
0080h – 008Fh	DMA page register	
0092h	System control register	*
0093h – 0097h	GPIO port 6,7,8,9,A direction control	*
0098h – 009Dh	GPIO port 0,1,2,3,4,5 direction control	*
00A0h – 00A1h	PIC 8259-2	*
00A8h – 00ADh	WatchDog1 control counter	*
00AEh	WatchDog1 reload counter	*
00C0h – 00DFh	DMA 8237-2	*
00E0h – 00EFh	DOS 4G Page access	*
0100h – 0105h	GPIO port 5,6,7,8,9,A default setup	*
0170h – 0177h	IDE 1(IRQ 15)	*
0278h – 027Fh	Printer port (IRQ7, DMA 0)	*
02E8h – 02EFh	COM4 (IRQ 11)	*
02F8h – 02EFh	COM2 (IRQ 3)	*
03E8h – 03EFh	COM3 (IRQ 10)	*
03F6h	IDE1 ATAPI device control write only register	*
03F8h – 03FFh	COM1 (IRQ 4)	*
0480h – 048Fh	DMA High page register	*
0490h – 0499h	Instruction counter register	*
04D0h – 04D1h	8259 Edge / level control register	*
0CF8h – 0CFFh	PCI configuration port	*
DE00h – DEFFh	On board LAN	*
FC00h – FC05h	SPI Flash BIOS control register	*

FC08h – FC0Dh	External SPI BUS control register	*
---------------	-----------------------------------	---

IRQ Mapping		
Address	Description	Usage
IRQ0	System Timer	*
IRQ1	Keyboard Controller	*
IRQ2	Cascade for IRQ8~15	
IRQ3	Serial port 2	*
IRQ4	Serial port 1	*
IRQ5	USB	*
IRQ6	USB	
IRQ7	Printer Port	*
IRQ8	Real Timer Clock	*
IRQ9	ACPI	*
IRQ10	Serial Port 3	*
IRQ11	Serial Port 4	*
IRQ12	Mouse	*
IRQ13	Math Coprocessor	*
IRQ14	Multimedia Device	*
IRQ15	Hard Disk Controller #2	*

DMA Mapping		
Address	Description	Usage
DMA0		
DMA1		
DMA2		
DMA3		
DMA4		
DMA5		
DMA6		
DMA7		

3 Software Resources

3.1 ICOP Technical Resource Website

In the following website, you will find our latest user manuals, including OS support resources systems such as evaluation images for Windows Embedded Compact 7, Windows Embedded CE 6.0, Windows Embedded CE 5.0, and Windows XP Embedded (Win XPe). For details, please kindly visit the following link:

<http://tech.icop.com.tw/>

3.2 Vortex86 Processor Programming Guide

Vortex86 processor programming guide is for software programmers to build their programs more quickly and easily on Vortex86 processor. This programming guide also includes the installation guide for X-Linux, Debian & Ubuntu Linux guide and board support package (BSP) for Windows Embedded OS on Vortex86SX/DX/MX. For details, please kindly visit the following link:

<http://www.dmp.com.tw/tech/>

4 Technical support

4.1 LCD

4.1.1 Introduction

The VDX3-6754 offers two different interfaces which support maximum resolution up to 1920 x 1080 (at 60MHz) connecting to LCD Flat Panel: 18-bit/24-bit TFT-LCD and 24-bit LVDS.

4.1.2 Pin Assignment of LVDS and TFT-LCD

LVDS Pin Assignment

LVDS Pin#	Pin Name	LVDS Pin#	Pin Name
1	VCC3 (+3.3V)	2	VCC3 (+3.3V)
3	GND	4	GND
5	Y0P	6	Y0M
7	Y1M	8	Y1P
9	Y2P	10	Y2M
11	GND	12	GND
13	CLKOUTM	14	CLKOUTP
15	Y3M	16	Y3P

TFT Flat Panel Data Output

LCD Pin#	Vortex86DX3 Pin Name	DIGITAL 18 bits	RGB 24 bits
1	LCDVCC (+3.3V)	VDD	VDD
2	LCDVCC (+3.3V)	VDD	VDD
3	FPD12	G2	G4
4	FPD13	G3	G5
5	FPD14	G4	G6
6	FPD15	G5	G7
7	FPD16	/	R0
8	FPD17	/	R1
9	FPD18	R0	R2
10	FPD19	R1	R3
11	FPD20	R2	R4
12	FPD21	R3	R5
13	FPD22	R4	R6
14	FPD23	R5	R7
15	GND	VSS	VSS
16	NC	/	/
17	NC	/	/
18	NC	/	/
19	NC	/	/
20	GND	VSS	VSS
21	PPD0	/	B0
22	PPD1	/	B1
23	PPD2	B0	B2
24	PPD3	B1	B3
25	PPD4	B2	B4
26	PPD5	B3	B5
27	PPD6	B4	B6
28	PPD7	B5	B7
29	PPD8	/	G0
30	PPD9	/	G1
31	PPD10	G0	G2
32	PPD11	G1	G3
33	GND	VSS	VSS
34	GND	VSS	VSS

35	NC	/	/
36	FP1CLK	XCLK	XCLK
37	NC	/	/
38	FP1DE	DEN	DEN
39	NC	/	/
40	FP1HS	HSYNC	HSYNC
41	NC	/	/
42	FP1VS	VSYNC	VSYNC
43	FPENBLT	ADJ	ADJ
44	FPENVDD	VDDEN	VDDEN

4.2.4 Serial ports Switching

Serial ports on VDX3-6754 are set RS232 as default. If you need RS485 be your default serial ports. Please contact your contact window directly or mail info@icop.com.tw. And you can refer to the below instruction to select the IRQ mode according to your demands.

Path: Advanced >Serial/Parallel Port Configuration

```

Advanced
*****
* SB Serial Port 1          [3F8]          * RDC Internal UART *
*   Serial Port IRQ 1      [IRQ4]          * Serial Port       *
*   Serial Port Boud Rate  [115200 BPS] *                  *
* PWM & COM2 Pin Select    [SB Serial Port 2] *                  *
* SB Serial Port 2         [2F8]          *                  *
*   Serial Port IRQ 2      [IRQ9]          *                  *
*   Serial Port Boud Rate  [115200 BPS] *                  *
* SB Serial Port 3         [3E8]          *                  *
*   Serial Port IRQ 3      [IRQ10]         *                  *
*   Serial Port Boud Rate  [115200 BPS] *                  *
* SB Serial Port 4         [2E8]          *                  *
*   Serial Port IRQ 4      [IRQ11]         *                  *
*   Serial Port Boud Rate  [115200 BPS] *                  *
* SB Parallel Port Address  [378]          * * Select Screen   *
*   Parallel Port Mode     [EPP 1.7 AND SPP] * ** Select Item   *
*   Parallel Port IRQ      [IRQ7]         * +- Change Option *
*                               * F1 General Help  *
*                               * F10 Save and Exit *
*                               * ESC Exit         *
*                               *                  *
*****
v02.67 (C)Copyright 1985-2009, American Megatrends, Inc.

```

4.2.5 IDE Configuration

The default IDE configuration is for Windows Operating System, and the setting as below:

**Onboard IDE Operate Mode: [Legacy Mode]
IDE Compatibility: [Disabled].**

If you would like to use Linux on VDX3-6754, please follow below instructions:

**Onboard IDE Operate Mode: [Native Mode]
IDE Compatibility: [Enabled].**

**Path of Onboard IDE Operate Mode:
Advanced >IDE Configuration >Onboard IDE Operate Mode
[Native Mode]**

```

Advanced
*****
* IDE Configuration                                     * ! Notice ! Native Mode *
* *****                                             * ONLY for Windows(R) XP *
* OnBoard PCI IDE Controller   [Secondary]             * and 2000.                *
* * Secondary IDE Master       : [Not Detected]        *                       *
* *                               *                       *                       *
* Hard Disk Write Protect      [Disabled]              *                       *
* IDE Detect Time Out (Sec)    [35]                   *                       *
* ATA(P/I) 80Pin Cable Detecti ***** Options ***** *
* Hard Disk Delay              * Legacy Mode          * *
* OnBoard IDE Operate Mode     * Native Mode         * *
* SATA PHY Speed               *****              * *
*                               *                       * *
*                               * * Select Screen   * *
*                               * * Select Item     * *
*                               * +- Change Option  * *
*                               * F1 General Help   * *
*                               * F10 Save and Exit * *
*                               * ESC Exit         * *
*                               *                       * *
*****
v02.67 (C)Copyright 1985-2009, American Megatrends, Inc.

```

Path of IDE Compatibility:

Advanced > SouthBridge Configuration > MISC Configuration > IDE Compatibility [Enabled]

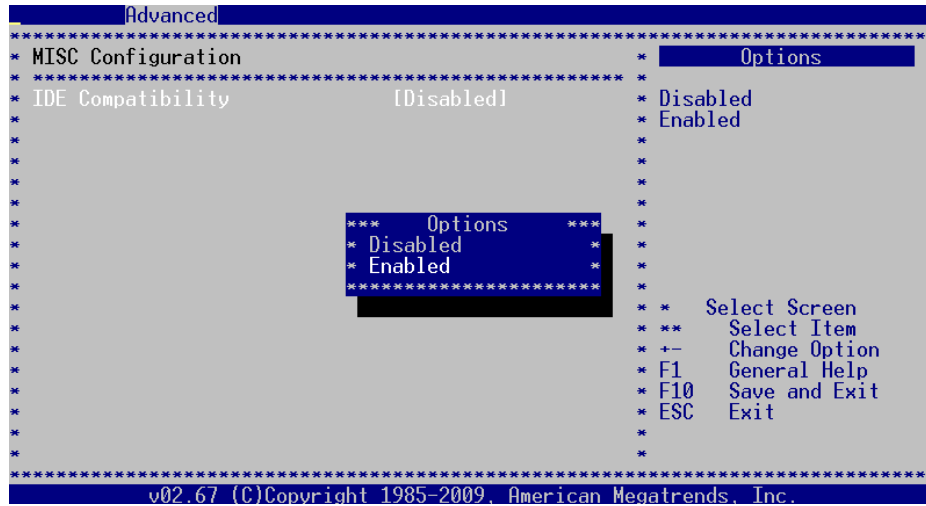

4.2.6 Advanced PCI/PnP Setting

Two statuses for IRQ setting:

[Reserved]: IRQ will be free to be allocated by ISA device, not PCI device.

[Available]: IRQ will be allocated by both ISA device and PCI device.

Path: PCIPnP >IRQ

```

Main    Advanced  PCIPnP    Boot    Security  Exit
*****
* Advanced PCI/PnP Settings                               ** Available: Specified *
* *****                                               ** IRQ is available to be *
* WARNING: Setting wrong values in below sections      ** used by PCI/PnP      *
*               may cause system to malfunction.       ** devices.             *
*                                                       ** Reserved: Specified *
* Clear NVRAM                                           ** IRQ is reserved for  *
* Plug & Play O/S                                       ** use by L             *
* PCI Latency Timer                                     ** devices.            *
* Allocate IRQ to PCI VGA                               **                       *
* Palette Snooping [Disabled]                          **                       *
* PCI IDE BusMaster [Enabled]                          **                       *
*                                                       **                       *
* IRQ3 [Reserved]                                       ** *   Select Screen   *
* IRQ4 [Reserved]                                       ** **  Select Item     *
* IRQ5 [Available]                                       ** +-  Change Option   *
* IRQ6 [Available]                                       ** F1  General Help    *
* IRQ7 [Available]                                       ** F10 Save and Exit   *
* IRQ9 [Reserved]                                       ** ESC  Exit           *
* IRQ10 [Available]                                      **                       *
* IRQ11 [Available]                                      **                       *
*****
v02.67 (C)Copyright 1985-2009, American Megatrends, Inc.
    
```

4.2.8 LCD Panel Setting

The default setting of **Boot Display Device [CRT]** and the **LCD Panel Index [VBIOS]** are for VGA signal.

If you need to use LCD panel with VDX3-6754, please follow below instructions:

Boot Display Device [IPD]

LCD Panel Index according to your LCD resolution from 1 to 5.

Options	Resolution of the LCD Panel
1	640 x 480
2	800 x 480
3	800 x 600
4	1024 x 600
5	1024 x 768

Path of Boot Display Device setting:

Boot >Boot Settings Configuration >Boot Display Device [IPD]



Path of LCD Panel Index setting:

Boot >Boot Settings Configuration >LCD Panel Index []

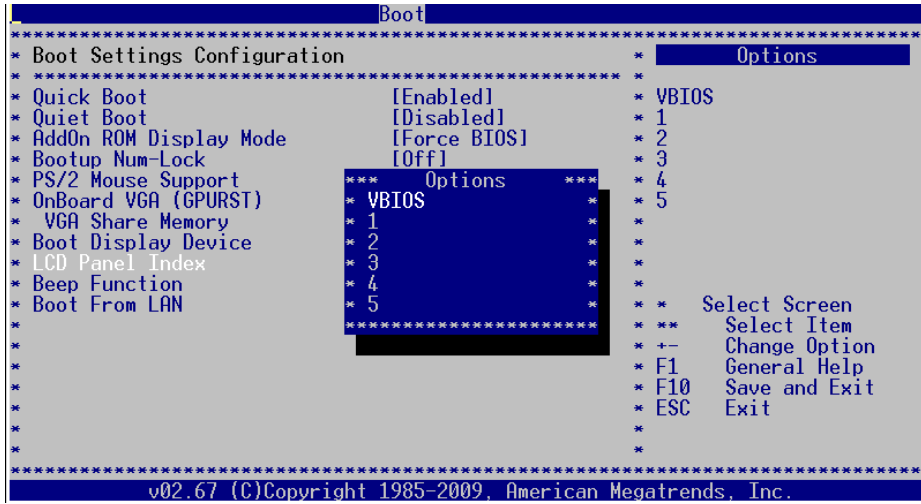

Warranty

This product is warranted to be in good working order for a period of one year (12 months) from the date of purchase. Should this product fail to be in good working order at any time during this period, we will, at our option, replace or repair it without additional charge except as set forth in the following terms. This warranty does not apply to products damaged by misuse, modifications, accident or disaster. Vendor assumes no liability for any damages, lost profits, lost savings or any other incidental or consequential damage resulting from the use, misuse of, originality to use this product. Vendor will not be liable for any claim made by any other related party. Return authorization must be obtained from the vendor before returned merchandise is accepted. Authorization can be obtained by calling or faxing the vendor and requesting a Return Merchandise Authorization (RMA) number. Returned goods should always be accompanied by a clear problem description. Should you have questions about warranty and RMA service, please contact us directly.

ICOP Technology Inc.

Address: No. 15 Wugong 5th Road, Xinzhuang Dist.

New Taipei City, Taiwan (R.O.C.) 24890

TEL: +886-2-8990-1933

FAX: +886-2-8990-2045

Mail: info@icop.com.tw

Website: <http://www.icop.com.tw>

