

IBW-6954

A PC/104 embedded solution on
Intel® Quad-core Processor
(Braswell Family)

Version 2.0

Copyright

The information in this manual is subject to change without notice for continuous improvement in the product. All rights are reserved. The manufacturer assumes no responsibility for any inaccuracies that may be contained in this document and makes no commitment to update or to keep current the information contained in this manual.

No part of this manual may be reproduced, copied, translated or transmitted, in whole or in part, in any form or by any means without the prior written permission of ICOP Technology Inc.

Copyright© 2021 ICOP Technology Inc.

Revision History

Revision	Date	Remark
1.0	March 11, 2020	First version release
2.0	July 20, 2021	Second version release

Table of Contents

1	General Information.....	1
1.1	Overview.....	1
1.2	Block diagram.....	1
1.3	Specifications.....	2
1.4	Ordering Information.....	4
1.4.1	Product Name	4
1.4.2	Optional Accessory	4
2	Hardware Information	5
2.1	Dimension.....	5
2.2	Board Outline.....	6
2.3	Connector and Jumper Summary.....	7
2.4	Pin Assignments & Jumper Settings.....	8
	J5: LAN	8
	J7: HDMI.....	8
	J9: MiniPCIe	9
	J10A & J10B: PC/104.....	10
	J11: Power for SATA HDD.....	11
	J12: SATA DOM	11
	J13: Speaker	11
	J14: Jumper Selection for AT/ATX	12
	J15: CMOS Battery.....	12
	J16: Line-out	12
	J17: MIC-in	13
	J18: I ² C	13

J19: PNT(default)/GPIO	14
J20: Reset	14
J21: Power selection for INV1	14
J23: Power Button.....	15
J25: COM1 (RS232)	15
J26: COM2 (RS232)	16
J27: COM3 (RS232/422/485)	16
J28: COM4 (RS232/422/485)	17
J30: Power Connector	17
J33: USB(2.0)	17
J34: VGA	18
J35: 4-pin Power Source	18
J36: USB(2.0)	18
J37: Clear CMOS.....	19
LVDS1: LVDS.....	19
INV1: LCD Backlight Control	20
Technical Support Directly from ICOP.....	20
User Manual Feedback	20
Warranty.....	21

1 General Information

1.1 Overview

IBW-6954, a PC/104 embedded solution for industrial application based on Intel® Braswell Quad-Core CPU with 4GB DDR3L RAM onboard, provides stable and powerful computing performance.

IBW-6954 supports Gigabit LAN, 4x COM, 4x USB, I²C, Parallel, Mini PCIe, HDMI, LVDS, VGA, and SATA interface for storage for development use.

1.2 Block diagram

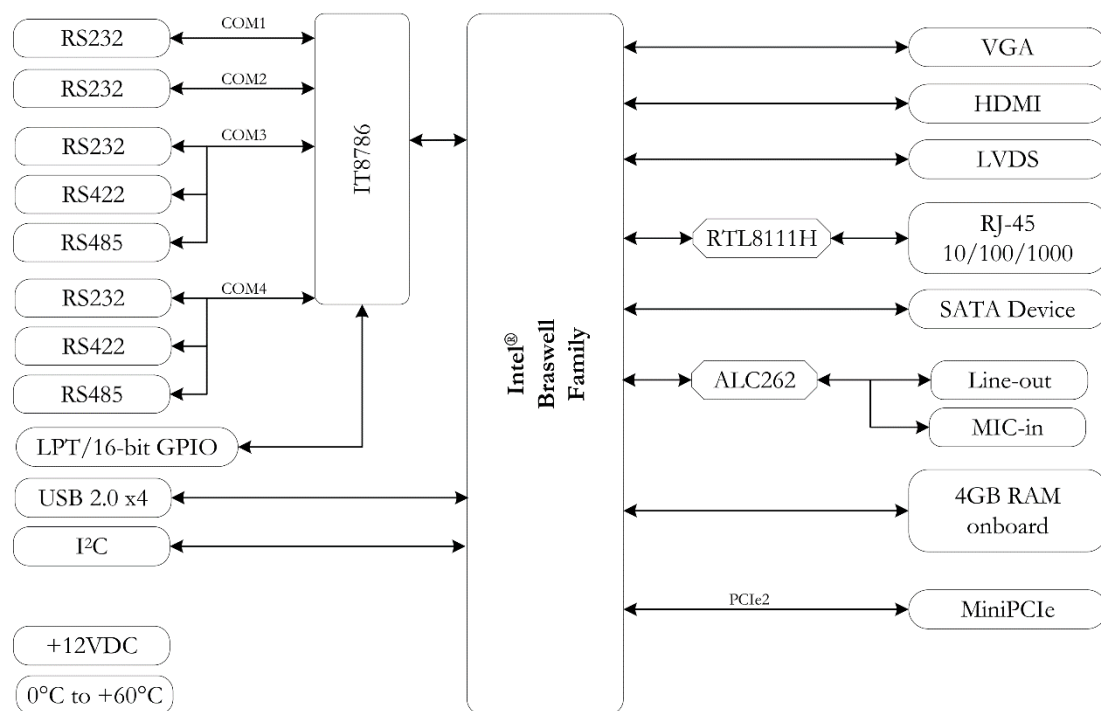

1.3 Specifications

Processor	Intel® Atom™ x5-E8000, 2.00GHz (Burst), 1.04GHz Quad Core Intel® Pentium® N3710, 2.56GHz (Burst), 1.6GHz Quad Core (Option) Intel® Celeron® N3160, 2.24GHz (Burst), 1.6GHz Quad Core (Option)
System Memory	4GB DDR3L 1600MHz onboard
BIOS	UEFI BIOS
Bus	MiniPCIe (full-size) x1 ISA Bus x1
Display	Hardware decoding: H.265, MPEG2, MVC, VC-1, VP8, WMV9, and JPEG/MJPEG formats Hardware encoding: H.264, MVC, and JPEG/MJPEG formats VGA: resolutions up to 1920 x 1200 @ 60Hz HDMI: resolutions up to 2560 x 1600 @ 60Hz, 24bpp LVDS: resolutions up to 1920 x 1200 @ 60Hz, in dual LVDS bus mode
LAN	Realtek 8111H GbE x1
HD Audio	Realtek ALC262 VD
Disk Support	SATA device x1 mSATA device x1 (Option)*
I/O Interface	COM x4 (2 for RS232/422/485) I ² C x1 USB 2.0 x4 Parallel x1 Audio (Line-out/MIC-in)

Connectors	5.40mm 7-pin Standard SATA connector x1 2.00mm 26-pin box header for Printer x1 2.00mm 12-pin header for LAN port x1 2.00mm 12-pin header for VGA port x1 2.00mm 10-pin box header for COM x4 2.00mm 10-pin box header for USB x4 2.00mm 2-pin box header for SATA Power x1 2.00mm 2-pin header for AT/ATX mode x1 2.00mm 2-pin header Power button x1 2.00mm 2-pin header for Reset x1 1.25mm 30-pin wafer for LVDS x1 1.25mm 4-pin header for I ² C x1 1.25mm 4-pin wafer for Line-out/MIC-in x2 1.25mm 2-pin header for CMOS battery x1 2-pin header for Speaker Standard PC/104 connector x1 HDMI connector x1 Terminal block for Power input x1 Mini PCIe slot x1
Power Requirement	5V DC
Operating Temp.	0°C to +55°C
Dimensions	116mm x 96mm
Weight	81g
O/S Support	Windows 10 Windows 7 (64bits) Linux

1.4 Ordering Information

1.4.1 Product Name

Product Name	IBW-6954-E4	IBW-6954-A4	IBW-6954-B4
Processor	1.04GHz (Intel® Atom™ x5-E8000)	1.60GHz (Intel® Pentium® N3710)	1.60GHz (Intel® Celeron® N3160)
Additional I/O			
MiniPCIE Slot	MiniPCIE device support		
System Memory	4GB DDR3L 1600MHz		
Accessory	CABLE-SATA-30CM x1		

Product Name	IBW-6954M-E4	IBW-6954M-A4	IBW-6954M-B4
Processor	1.04GHz (Intel® Atom™ x5-E8000)	1.60GHz (Intel® Pentium® N3710)	1.60GHz (Intel® Celeron® N3160)
Additional I/O			
MiniPCIE Slot	MSATA support		
System Memory	4GB DDR3L 1600MHz		
Accessory	CABLE-SATA-30CM x1		

1.4.2 Optional Accessory

Cable-set-6954	Cable set for IBW-6954 (RS232x4, USBx2, PRINT, Audio x2, LAN, VGA)
-----------------------	--

2 Hardware Information

2.1 Dimension

Top:

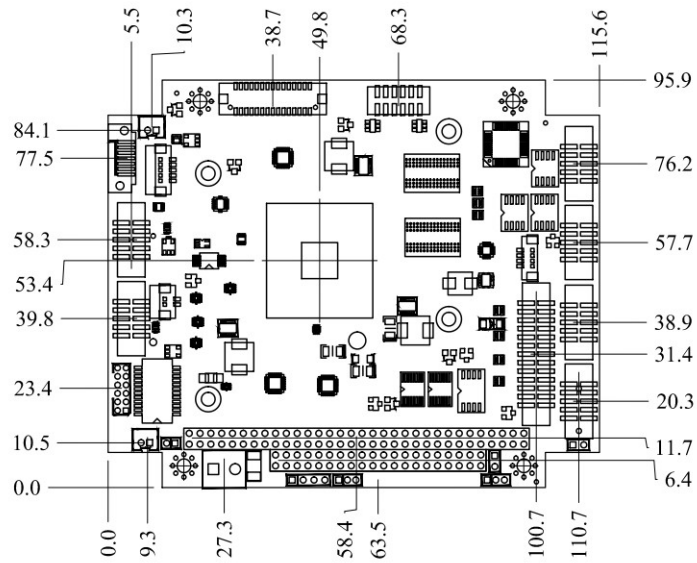

Bottom:

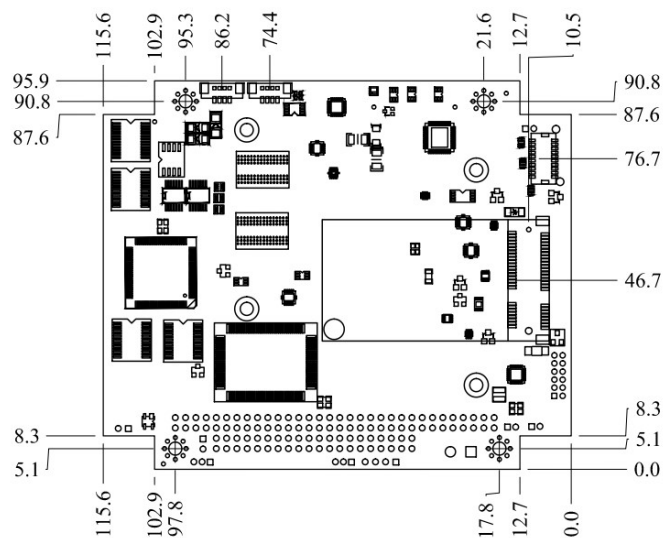

2.2 Board Outline

Top:

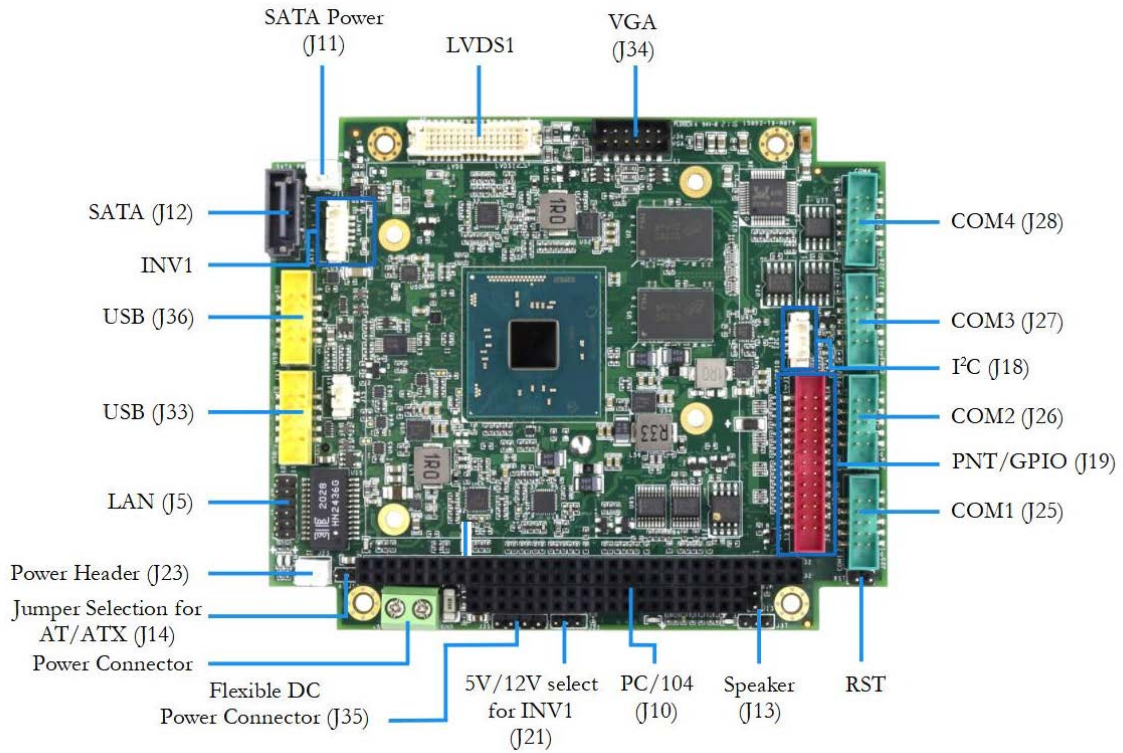

Bottom:

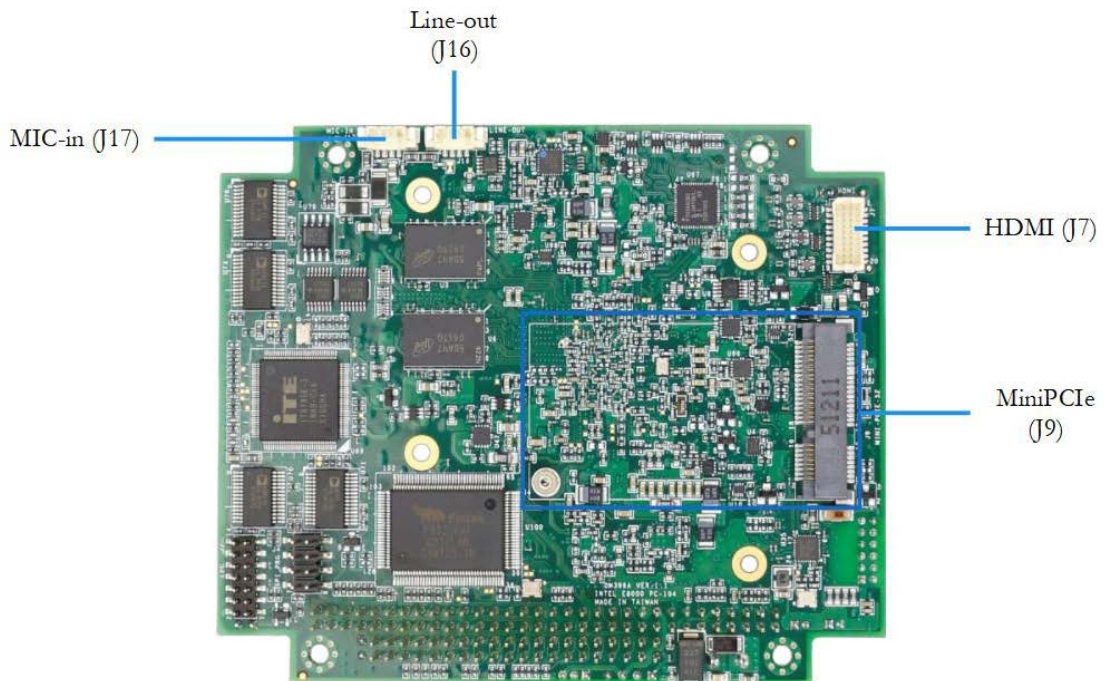

2.3 Connector and Jumper Summary

Nbr.	Name	Type of Connections	Nbr of Pin
J5	LAN	Pin Header, 2.0mm, 6x2	12
J7	HDMI	Wafer, 1.0mm, 10x2	20
J9	MiniPCIe / MSATA	Standard Mini PCIe connector	
J10A	PC/104	Standard PC/104 connector	
J10B			
J11	Power for SATA HDD	Box Header, 2.0mm, 2x1	2
J12	SATA DOM	SATA 7p Connector, 7x1	7
J13	Speaker	Pin Header, 2x1	2
J14	Jumper Selection for AT/ATX	Pin Header, 2.0mm, 2x1	2
J15	CMOS Battery	Wafer, 1.25mm, 2x1	2
J16	Line-out	Wafer, 1.25mm, 4x1	4
J17	MIC-in	Wafer, 1.25mm, 4x1	4
J18	I ² C	Wafer, 1.25mm, 4x1	4
J19	PNT	Box Header, 2.0mm, 13x2	26
J20	Reset	Pin Header, 2.0mm, 2x1	2
J21	Power selection for INV1	Pin Header, 2.0mm, 3x1	3
J23	Power Button	Box Header, 2.0mm, 2x1	2
J25	COM1 (RS232)	Box Header, 2.0mm, 5x2	10
J26	COM2 (RS232)	Box Header, 2.0mm, 5x2	10
J27	COM3 (RS232/422/485)	Box Header, 2.0mm, 5x2	10
J28	COM4 (RS232/422/485)	Box Header, 2.0mm, 5x2	10
J30	Power Connector	Terminal Block, 5.0mm, 2x1	2
J33	USB(2.0)	Box Header, 2.0mm, 5x2	10
J34	VGA	Box Header, 2.0mm, 6x2	12
J35	4-pin Power Source	Pin Header, 2.54mm, 4x1	4
J36	USB(2.0)	Box Header, 2.0mm, 5x2	10
J37	Clear CMOS	Pin Header, 3x1	3
LVDS1	LVDS	Wafer, 1.25mm, 15x2	30
INV1	LCD Backlight Control	Wafer, 2.0mm, 5x1	5

2.4 Pin Assignments & Jumper Settings

J5: LAN

12-pin header(2.0mm) for LAN port.

Pin#	Signal Name	Pin#	Signal Name
1	HGTX+1	2	HGTX-1
3	HGRX+1	4	HGRX-1
5	HGTXC+1	6	HGTXC-1
7	HGRXD+1	8	HGRXD-1
9	LED0+1	10	LED0
11	LED1+1	12	LED1/EESK

J7: HDMI

20-pin wafer(1.0mm) for HDMI.

Pin#	Signal Name	Pin#	Signal Name
1	HDMI_DATA2_R_DP	2	-
3	HDMI_DATA2_R_DN	4	GND
5	GND	6	HDMI_CLK_R_DP
7	HDMI_DATA1_R_DP	8	HDMI_CLK_R_DN
9	HDMI_DATA1_R_DN	10	GND
11	GND	12	HDMI_DDPC_SCL
13	HDMI_DATA0_R_DP	14	HDMI_DDPC_SDA
15	HDMI_DATA0_R_DN	16	GND
17	VCC5_S	18	HDMI_HPD
19	GGND	20	GGND

J9: MiniPCIe

Standard 52-pin female Mini PCI Express connector.

Pin#	Signal Name	Pin#	Signal Name
1	WAKE_(LAN)_3P3_N	2	VCC3P3_S
3	NC	4	GND
5	NC	6	NC
7	PCIE2_CLKREQ2_N	8	NC
9	GND	10	NC
11	MINI_PCIE_CLK2_DN	12	NC
13	MINI_PCIE_CLK2_DP	14	NC
15	GND	16	NC
Mechanical Key			
17	NC	18	GND
19	NC	20	NC
21	GND	22	PLTRST_3P3_N
23	PCIE2_RXP	24	VCC3P3_S
25	PCIE2_RXN	26	GND
27	GND	28	NC
29	GND	30	SMB_CLK_P2
31	PCIE2_TXN	32	SMB_DAT_P2
33	PCIE2_TXP	34	GND
35	GND	36	XUSB2-
37	GND	38	XUSB2+
39	VCC3P3_S	40	GND
41	VCC3P3_S	42	NC
43	GND	44	NC
45	NC	46	NC
47	NC	48	NC
49	NC	50	GND
51	NC	52	VCC3P3_S

* [J9] could be configured as mSATA interface through H/W modification.

J10A & J10B: PC/104

Standard PC/104 connector.

J10A				J10B			
Pin#	Signal Name	Pin#	Signal Name	Pin#	Signal Name	Pin#	Signal Name
B1	GND	A1	IOCHCK#	D1	GND	C1	GND
B2	XXRSTDRV	A2	SD7	D2	MECS16#	C2	SBHE#
B3	VCC5V_S	A3	SD6	D3	IOCS16#	C3	LA23
B4	XIRQ9	A4	SD5	D4	IRQ10	C4	LA22
B5	-5V	A5	SD4	D5	IRQ11	C5	LA21
B6	XDRQ2	A6	SD3	D6	IRQ12	C6	LA20
B7	-12V	A7	SD2	D7	IRQ15	C7	LA19
B8	XOWS	A8	SD1	D8	IRQ14	C8	LA18
B9	+12V	A9	SD0	D9	NC	C9	LA17
B10	GND	A10	IOCHRDY	D10	NC	C10	MEMR#
B11	SMEMW#	A11	AEN	D11	NC	C11	MEMW#
B12	SMEMR#	A12	SA19	D12	NC	C12	SD8
B13	IOW#	A13	SA18	D13	NC	C13	SD9
B14	IOR#	A14	SA17	D14	NC	C14	SD10
B15	NC	A15	SA16	D15	NC	C15	SD11
B16	NC	A16	SA15	D16	NC	C16	SD12
B17	NC	A17	SA14	D17	VCC5V_S	C17	SD13
B18	NC	A18	SA13	D18	MASTER#	C18	SD14
B19	REFRESH#	A19	SA12	D19	GND	C19	SD15
B20	SYSCLK	A20	SA11	D20	GND	C20	NC
B21	IRQ7	A21	SA10				
B22	IRQ6	A22	SA9				
B23	IRQ5	A23	SA8				
B24	IRQ4	A24	SA7				
B25	IRQ3	A25	SA6				
B26	NC	A26	SA5				
B27	TC	A27	SA4				
B28	BALE	A28	SA3				
B29	VCC5V_S	A29	SA2				
B30	XXOSC	A30	SA1				
B31	GND	A31	SA0				
B32	GND	A32	GND				

J11: Power for SATA HDD

2-pin box header(2.0mm) for SATA HDD power.

Pin#	Signal Name
1	VCC5V_S
2	GND

J12: SATA DOM

7-pin SATA connector(5.4mm) for SATA DOM.

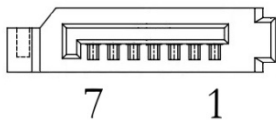

Pin#	Signal Name
1	GND
2	SATA_TXP
3	SATA_TXN
4	GND
5	SATA_RXN
6	SATA_RXP
7	GND

J13: Speaker

2-pin pin header for Speaker interface.

Pin#	Signal Name
1	SPKR
2	VCC5_S

J14: Jumper Selection for AT/ATX

2-pin pin header(2.0mm) jumper selection for AT/ATX mode.



[J14] Closed → AT mode

[J14] Open → ATX mode

J15: CMOS Battery

2-pin wafer(1.25mm) for CMOS battery.

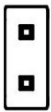

Pin#	Signal Name
1	VCC3P3
2	GND

J16: Line-out

4-pin wafer(1.25mm) for Line-out interface.

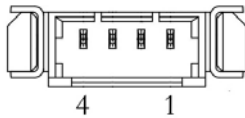

Pin#	Signal Name
1	LOUT_R
2	GND
3	LOUT_L
4	GND

J17: MIC-in

4-pin wafer(1.25mm) for MIC-in function.

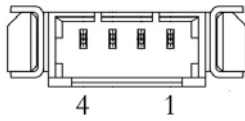

Pin#	Signal Name
1	MIC_IN_R
2	GND
3	MIC_IN_L
4	GND

J18: I²C

4-pin wafer(1.25mm) for I²C interface.

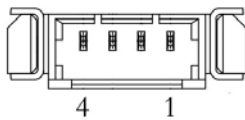

Pin#	Signal Name
1	GND
2	I2C5_SDA_3P3
3	I2C5_SCL_3P3
4	VCC3

J19: PNT(default)/GPIO

26-pin box header(2.0mm) for Print or GPIO interface.

Pin#	Signal Name	Pin#	Signal Name
1	STB-/GP87	2	PD0/GP70
3	PD1/GP71	4	PD2/GP72
5	PD3/GP73	6	PD4/GP74
7	PD5/GP75	8	PD6/GP76
9	PD7/GP77	10	ACK-/GP83
11	BUSY/GP82	12	PE/GP81
13	SLCT/GP80	14	AFD-/GP86
15	ERR-/	16	INIT-/GP85
17	SLIN-/GP84	18	GND
19	GND	20	GND
21	GND	22	GND
23	GND	24	GND
25	GND	26	GND

J20: Reset

2-pin pin header(2.0mm) for Reset button.

Pin#	Signal Name
1	RSTBTN
2	GND

J21: Power selection for INV1

3-pin pin header for INV1 power selection

Pin#	Signal Name
1	5V
2	GND
3	12V

Pin1 & 2 Closed → VCC 5V

Pin2 & 3 Closed → VCC 12V

J23: Power Button

2-pin box header(2.0mm) for Power button.

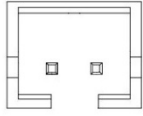

2 1

Pin#	Signal Name
1	PWRBTN
2	GND

J25: COM1 (RS232)

10-pin male box header(2.0mm) for COM1.

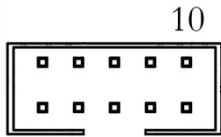

1

Pin#	Signal Name	Pin#	Signal Name
1	DCD1	2	RXD1
3	TXD1	4	DTR1
5	GND	6	DSR1
7	RTS1	8	CTS1
9	RI1	10	VCC5

J26: COM2 (RS232)

10-pin male box header(2.0mm) for COM2.

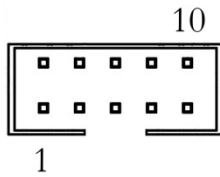

Pin#	Signal Name	Pin#	Signal Name
1	DCD2	2	RXD2
3	TXD2	4	DTR2
5	GND	6	DSR2
7	RTS2	8	CTS2
9	RI2	10	VCC5

J27: COM3 (RS232/422/485)

10-pin male box header(2.0mm) for COM3. COM3 can be RS232 or RS485 through RS232/422/485.

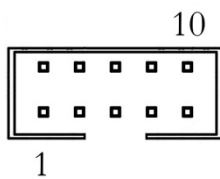

Pin#	Signal Name	Pin#	Signal Name
1	DCD3/422TX-3 /1RS485-3	2	RXD3/422TX+3 /1RS485+3
3	TXD3/422RX+3	4	DTR3/422RX-3
5	GND	6	DSR3
7	RTS3	8	CTS3
9	RI3	10	VCC5

J28: COM4 (RS232/422/485)

10-pin male box header(2.0mm) for COM4. COM4 can be RS232 or RS485 through RS232/422/485.

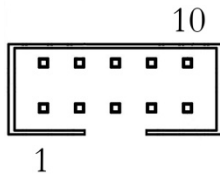

Pin#	Signal Name	Pin#	Signal Name
1	DCD4/422TX-4 /2RS485-4	2	RXD4/422TX+4 /2RS485+4
3	TXD4/422RX+4	4	DTR4/422RX-4
5	GND	6	DSR4
7	RTS4	8	CTS4
9	RI4	10	VCC5

J30: Power Connector

2-pin terminal block(5.0mm) for Power connector.

Pin#	Signal Name	Pin#	Signal Name
1	VCC5V_A	2	GND

J33: USB(2.0)

10-pin box header(2.0mm) for USB 2.0 interface.

Pin#	Signal Name	Pin#	Signal Name
1	VCC5V_A	2	VCC5V_A
3	USB2_DN_2	4	USB2_DN_3
5	USB2_DP_2	6	USB2_DP_3
7	GND	8	GND
9	GGND	10	GGND

J34: VGA

12-pin box header(2.0mm) for VGA.

Pin#	Signal Name	Pin#	Signal Name
1	ROUT	2	GND
3	GOUT	4	GND
5	BOUT	6	GND
7	HSYNC_A	8	GND
9	VSYNC_A	10	GND
11	VGASCL	12	VGASDA

J35: 4-pin Power Source

4-pin wafer(2.0mm) for PC/104 power transformer.

Pin#	Signal Name
1	-5V
2	-12V
3	+12V
4	GND

J36: USB(2.0)

10-pin box header(2.0mm) for USB 2.0 interface.

Pin#	Signal Name	Pin#	Signal Name
1	VCC5V_A	2	VCC5V_A
3	USB2_DN_0	4	USB2_DN_1
5	USB2_DP_0	6	USB2_DP_1
7	GND	8	GND
9	GGND	10	GGND

J37: Clear CMOS

3-pin pin header for clearing CMOS setting

Pin#	Signal Name
1	NC
2	VCC3PC_RTC
3	GND

Pin1 & 2 Closed → Keep CMOS setting

Pin2 & 3 Closed → Clear CMOS setting

LVDS1: LVDS

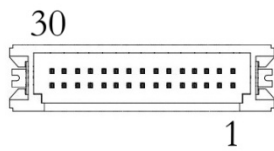

Pin#	Signal Name	Pin#	Signal Name
1	3.3V	2	3.3V
3	GND	4	GND
5	LVDS_A0+	6	LVDS_A0-
7	LVDS_A1-	8	LVDS_A2+
9	LVDS_A2+	10	LVDS_A2-
11	GND	12	GND
13	LVDS_ACLK-	14	LVDS_ACLK+
15	LVDS_A3-	16	LVDS_A3+
17	LVDS_B0+	18	LVDS_B0-
19	GND	20	GND
21	LVDS_B1-	22	LVDS_B1+
23	LVDS_B2+	24	LVDS_B2-
25	LVDS_B3+	26	LVDS_B3-
27	DDC_SDA	28	DDC_CLK
29	LVDS_BCLK+	30	LVDS_BCLK-

INV1: LCD Backlight Control

Pin1 5V/12 voltage configure by J21

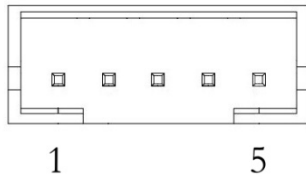

Pin#	Signal Name
1	5V/12V
2	GND
3	L_BKLT_EN
4	LCD_BKLT_CTRL
5	GND

Technical Support Directly from ICOP

To offer you more accurate and specific solutions for the technical situations you have, please prepare the information below before contacting ICOP:

—Product name and serial number

—Description of the H/W environment (i.e.: working temperature, I/O board information, information of connection between main board and IO boards, and/or other devices, etc)

—Description of the S/W environment (i.e: operating system, version, application software, and/or other related information, etc.)

—A detailed description and photos of the technical situation

—Any complement or technical situations you want ICOP more focusing on

User Manual Feedback

To make this user manual more complete, if you have any comments or feedbacks to this manual, please feel free to write to info@icop.com.tw or contact your ICOP sales representative.

Warranty

This product is warranted to be in good working order for a period of one year (12 months) from the date of purchase. Should this product fail to be in good working order at any time during this period, we will, at our option, replace or repair it without additional charge except as set forth in the following terms. This warranty does not apply to products damaged by misuse, modifications, accident or disaster. Vendor assumes no liability for any damages, lost profits, lost savings or any other incidental or consequential damage resulting from the use, misuse of, originality to use this product. Vendor will not be liable for any claim made by any other related party. Return authorization must be obtained from the vendor before returned merchandise is accepted. Authorization can be obtained by calling or faxing the vendor and requesting a Return Merchandise Authorization (RMA) number. Returned goods should always be accompanied by a clear problem description. Should you have questions about warranty and RMA service, please contact us directly.

ICOP Technology Inc.

Address: No. 15 Wugong 5th Road, Xinzhuang Dist.

New Taipei City, Taiwan (R.O.C.) 24890

TEL: +886-2-8990-1933

FAX: +886-2-8990-2045

Mail: info@icop.com.tw

Website: <http://www.icop.com.tw>

